

# CONTRACT

FURNITURE FOR PROFESSIONALS CATALOGUE

by **mhr**<sup>®</sup>  
UPHOLSTERY





# CONTRACT

FURNITURE FOR PROFESSIONALS CATALOGUE

by **mhr**<sup>®</sup>  
UPHOLSTERY



# CONTRACT

by **mhr**<sup>®</sup>  
UPHOLSTERY

---

Esta é a nossa visão através da nossa experiência, orientada para o universo Contract:  
Acrescentar conforto e design a espaços que devem ser apelativos, funcionais e resistentes.  
Aqui encontra uma seleção de peças que vão ao encontro desta necessidade cada vez mais importante.

*This is our vision through our experience, aimed to the Contract universe:  
Adding comfort and design to spaces that must be appealing, functional and resistant.  
Here you will find a selection of pieces that meet this increasingly important need.*

Esta es nuestra visión a través de nuestra experiencia, dirigida al universo Contract:  
Sumar confort y diseño a espacios que deben ser atractivos, funcionales y resistentes.  
Aquí encontrarás una selección de piezas que cubren esta necesidad cada vez más importante.

*C'est notre vision à travers notre expérience, destinée à l'univers Contract :  
Apporter confort et design à des espaces qui doivent être esthétiques, fonctionnels et résistants.  
Vous trouverez ici une sélection de pièces qui répondent à ce besoin de plus en plus important.*

---

## Sofas & Sleepers

---



**09** | Sleeper M-01



**13** | Sleeper M-02



**17** | Sleeper M-03



**21** | Sleeper M-04



**25** | Sleeper M-05

---

## Sommiers & Headboards

---



**48** | Sommier MP-5



**49** | Sommier MP-10



**51** | Headboard M-101



**55** | Headboard M-102



**59** | Headboard M-103

---

## Armchairs

---



**81** | M-51



**85** | M-52



**89** | M-53



**93** | M-54



**97** | M-55

---

## Pouffs

---



**103** | M-201



**105** | M-202



**107** | M-203



**109** | M-204

---

## Bar Sofas

---



**113** | M-51



**117** | M-52



29 | Sleeper M-06



33 | Sleeper M-07



39 | Sleeper M-08



43 | Sofa M-09



63 | Headboard M-104



67 | Headboard M-105



71 | Headboard M-106



75 | Headboard M-107



Sleeper M-01



Sleeper M-02



Sleeper M-03



Sleeper M-04



Sleeper M-05



Sleeper M-06



Sleeper M-07



Sofa/Sleeper M-08



Sofa M-09







# Sleeper M-01

---

Conforto em linhas simples.  
*Comfort in simple lines.*  
Comodidad en líneas simples  
*Confort dans des lignes simples.*

---





Com mecanismo Ref. ID.  
 With Ref. ID mechanism.  
 Con mecanismo Ref. ID.  
 Avec mécanisme Réf. ID.

M-01 SPECIFICATIONS

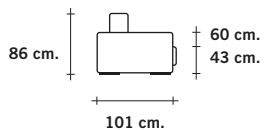

Sofá . Sofa . Sofá . Canapé

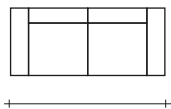

- 90 | 131 cm.
- 120 | 161 cm.
- 140 | 181 cm.
- 160 | 201 cm.
- 180 | 221 cm.

Cama . Bed . Cama . Lit

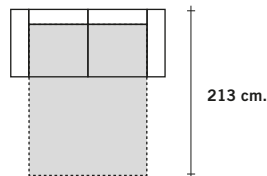

Mecanismo . Mechanism  
 Menatismo . Mécanisme

Ref. ID

Colchão . Mattress . Colchón . Matelas

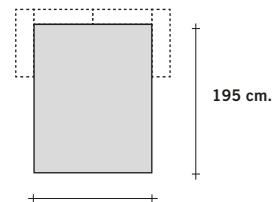

- 90 | 70 cm.
- 120 | 100 cm.
- 140 | 120 cm.
- 160 | 140 cm.
- 180 | 160 cm.





REVIEW

I really  
I have enjoyed staying at  
and we will be staying  
Sally  
2018

# Sleeper M-02

---

A flexibilidade, na maior simplicidade.

*Flexibility, in the greatest simplicity.*

Flexibilidad, en la mayor sencillez.

*La flexibilité, dans la plus grande simplicité.*

---









Com mecanismo Ref. ID.  
 With Ref. ID mechanism.  
 Con mecanismo Ref. ID.  
 Avec mécanisme Réf. ID.

M-02 SPECIFICATIONS

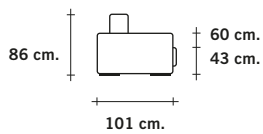

Sofá . Sofa . Sofá . Canapé

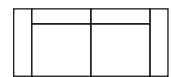

- 90 | 115 cm.
- 120 | 145 cm.
- 140 | 165 cm.
- 160 | 185 cm.
- 180 | 205 cm.

Cama . Bed . Cama . Lit

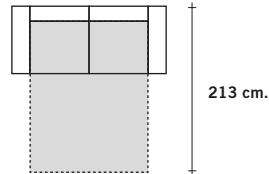

Mecanismo . Mechanism  
 Menanismo . Mécanisme

Ref. ID

Colchão . Mattress . Colchón . Matelas

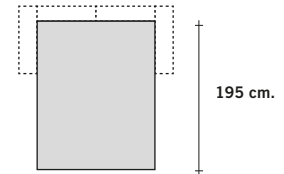

- 90 | 70 cm.
- 120 | 100 cm.
- 140 | 120 cm.
- 160 | 140 cm.
- 180 | 160 cm.



# Sleeper M-03

---

Versátil e elegante. Dimensionado à necessidade.

*Versatile and elegant. Sized to need.*

Versátil y elegante. Tamaño a la necesidad.

*Polyvalent et élégant. Dimensionné au besoin.*

---





Com mecanismo Ref. ID.  
 With Ref. ID mechanism.  
 Con mecanismo Ref. ID.  
 Avec mécanisme Réf. ID.

## M-03 SPECIFICATIONS

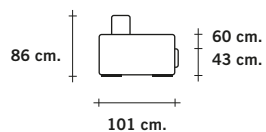

Sofá . Sofa . Sofá . Canapé

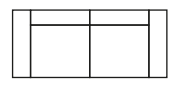

■ 90 | 99 cm.  
 ■ 120 | 129 cm.  
 ■ 140 | 149 cm.  
 ■ 160 | 169 cm.  
 ■ 180 | 189 cm.

Cama . Bed . Cama . Lit

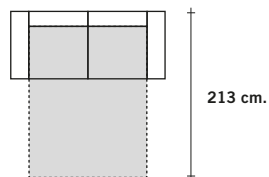

Mecanismo . Mechanism  
 Menanismo . Mécanisme

Ref. ID

Colchão . Mattress . Colchón . Matelas

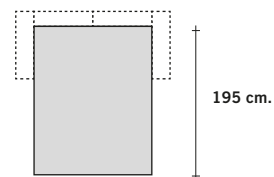

■ 90 | 70 cm.  
 ■ 120 | 100 cm.  
 ■ 140 | 120 cm.  
 ■ 160 | 140 cm.  
 ■ 180 | 160 cm.





# Sleeper M-04

---

Conforto e mobilidade orientados às necessidades.

*Need-oriented comfort and mobility.*

Comodidad y movilidad orientadas a las necesidades.

*Confort et mobilité adaptés aux besoins.*

---









Com mecanismo Ref. NIDO.  
 With Ref. NIDO mechanism.  
 Con mecanismo Ref. NIDO.  
 Avec mécanisme Réf. NIDO.

M-04 SPECIFICATIONS

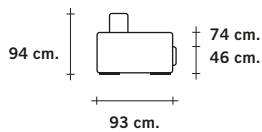

Sofá . Sofa . Sofá . Canapé

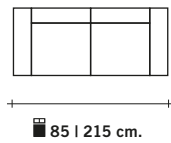

Cama . Bed . Cama . Lit

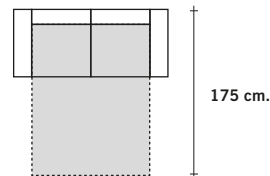

Mecanismo . Mechanism  
 Menanismo . Mécanisme

Ref. NIDO

Colchão . Mattress . Colchón . Matelas

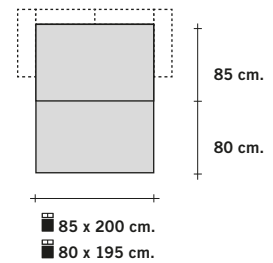



# Sleeper M-05

---

Uma nova forma, um volume diferente.

*A new form, a different volume.*

Una nueva forma, un volumen diferente.

*Une nouvelle forme, un volume différent.*

---





Com mecanismo Ref. ID.  
 With Ref. ID mechanism.  
 Con mecanismo Ref. ID.  
 Avec mécanisme Réf. ID.

## M-05 SPECIFICATIONS

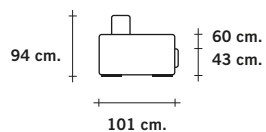

Sofá . Sofa . Sofá . Canapé

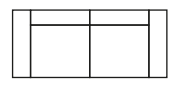

- 90 | 130 cm.
- 120 | 160 cm.
- 140 | 180 cm.
- 160 | 200 cm.
- 180 | 220 cm.

Cama . Bed . Cama . Lit

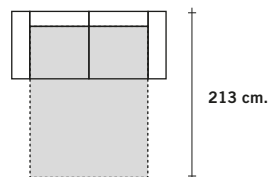

Mecanismo . Mechanism  
 Menismo . Mécanisme

Ref. ID

Colchão . Mattress . Colchón . Matelas

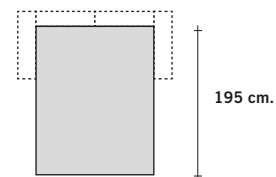

- 90 | 70 cm.
- 120 | 100 cm.
- 140 | 120 cm.
- 160 | 140 cm.
- 180 | 160 cm.



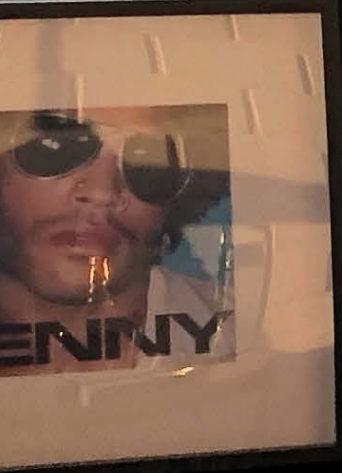

# Sleeper M-06

---

Elegância e conforto elevados ao expoente máximo.

*Elegance and comfort elevated to the maximum exponent.*

Elegancia y confort elevados al máximo exponente.

*Élégance et confort élevés au maximum.*

---









Com mecanismo Ref. ID.  
 With Ref. ID mechanism.  
 Con mecanismo Ref. ID.  
 Avec mécanisme Réf. ID.

M-06 SPECIFICATIONS

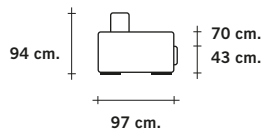

Sofá . Sofa . Sofá . Canapé



- 90 | 105 cm.
- 120 | 135 cm.
- 140 | 155 cm.
- 160 | 175 cm.
- 180 | 195 cm.

Cama . Bed . Cama . Lit

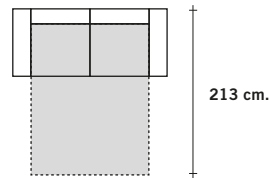

Mecanismo . Mechanism  
 Menanismo . Mécanisme

Ref. ID

Colchão . Mattress . Colchón . Matelas

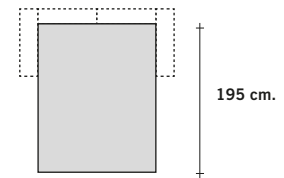

- 90 | 70 cm.
- 120 | 100 cm.
- 140 | 120 cm.
- 160 | 140 cm.
- 180 | 160 cm.



# Sleeper M-07

---

Simplicidade e elegância de linhas rectas.  
*Simplicity and elegance of straight lines.*  
Sencillez y elegancia de líneas rectas.  
*Simplicité et élégance des lignes droites.*

---





---

Versatilidade como forma de expressão.  
*Versatility as a form of expression.*  
La versatilidad como forma de expresión.  
*La polyvalence comme forme d'expression.*

---





Com mecanismo Ref. ID.  
 With Ref. ID mechanism.  
 Con mecanismo Ref. ID.  
 Avec mécanisme Réf. ID.

M-07 SPECIFICATIONS

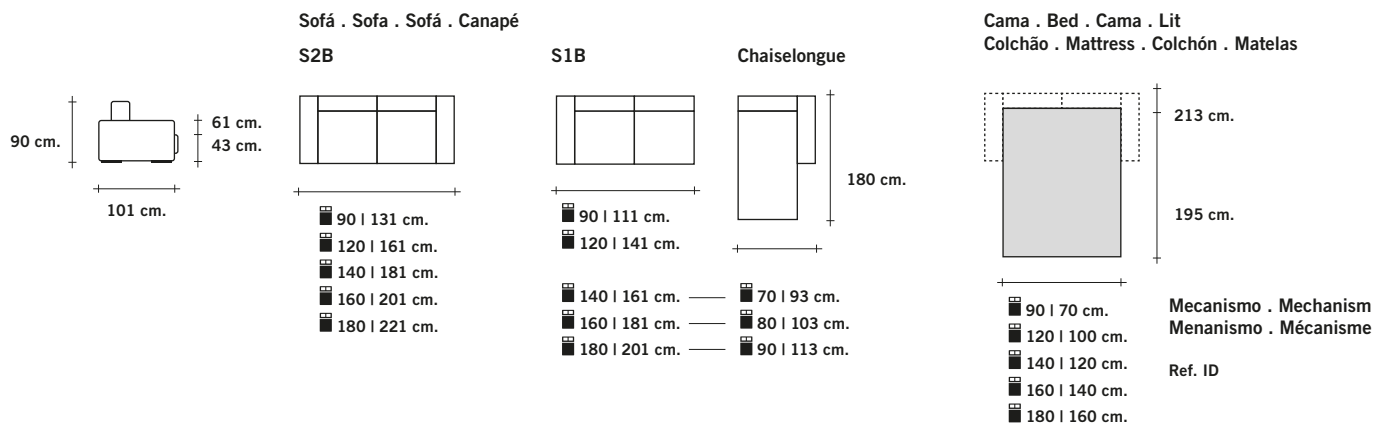







# Sofa/Sleeper M-08

---

Intemporal, contemporâneo, funcional.

*Timeless, contemporary, functional.*

Atemporal, contemporâneo, funcional.

*Intemporel, contemporain, fonctionnel.*

---







Com mecanismo Ref. 2D.  
 With Ref. 2D mechanism.  
 Con mecanismo Ref. 2D.  
 Avec mécanisme Réf. 2D.

M-08 SPECIFICATIONS

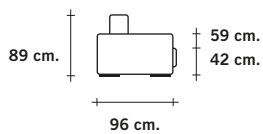

Sofá . Sofa . Sofá . Canapé

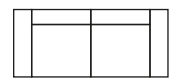

2 ↓ 180 cm.  
 3 ↓ 200 cm.

■ 133 | 180 cm.  
 ■ 153 | 200 cm.

Cama . Bed . Cama . Lit

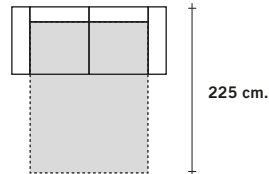

Mecanismo . Mechanism  
 Menanismo . Mécanisme

Ref. 2D

Colchão . Mattress . Colchón . Matelas

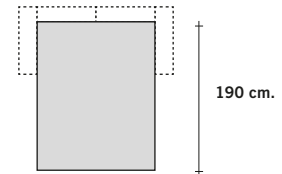

■ 133 | 113 cm.  
 ■ 153 | 133 cm.



# Sofa M-09

---

Reinterpretação moderna de um clássico.  
*A modern reinterpretation of a classic.*  
Reinterpretación moderna de un clásico.  
*Réinterprétation moderne d'un classique.*

---





## M-09 SPECIFICATIONS

## Sofá . Sofa . Sofá . Canapé

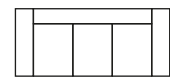
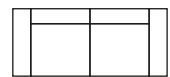
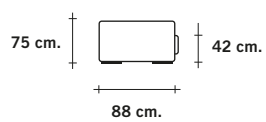





Sommier MP-5



Sommier MP-10



Headboard M-101



Headboard M-102



Headboard M-103



Headboard M-104



Headboard M-105



Headboard M-106



Headboard M-107



# Sommiers & Headboards

---

Diversas combinações possíveis. Desde a base à cabeceira, tudo pode ser conjugado de acordo com a dinâmica do espaço.

*Several possible combinations. From the base to the headboard, everything can be combined according to the dynamics of the space.*

Varias combinaciones posibles. Desde la base hasta el cabecero, todo se puede combinar según la dinámica del espacio.

*Plusieurs combinaisons possibles. Du sommier à la tête de lit, tout peut être combiné selon la dynamique de l'espace.*

---

# Sommier MP-5

Elegante, prática, versátil e de pé baixo.  
*Elegant, practical, versatile and low standing.*  
 Elegantes, prácticas, versátiles y de pie bajo.  
*Elégant, pratique, polyvalent et bas.*



## MP-05 SPECIFICATIONS

30 cm | 5 + 25 cm.

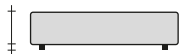

■ 190 | 193cm.  
 ■ 195 | 198 cm.  
 ■ 200 | 203cm.

### Sommier . Sommier . Somier . Sommier

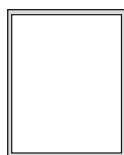

■ 90 | 93 cm.  
 ■ 140 | 143 cm.  
 ■ 150 | 153 cm.  
 ■ 160 | 163 cm.  
 ■ 180 | 183 cm.

■ 190 | 193cm.  
 ■ 195 | 198 cm.  
 ■ 200 | 203cm.

### Colchão . Mattress . Colchón . Matelas



■ 90 | 90 cm.  
 ■ 140 | 140 cm.  
 ■ 150 | 150 cm.  
 ■ 160 | 160 cm.  
 ■ 180 | 180 cm.

■ 190 | 190cm.  
 ■ 195 | 195 cm.  
 ■ 200 | 200cm.

# Sommier MP-10

A mesma visão anterior, mas desta feita, com o pé alto.

*Same view as before, but this time with the foot high.*

La misma vista que antes, pero esta vez, con el pie en alto.

*La même vue que précédemment, mais cette fois-ci, avec le pied haut.*



## MP-10 SPECIFICATIONS

### Sommier . Sommier . Somier . Sommier

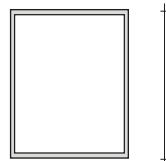

■ 190 | 193cm.  
■ 195 | 198 cm.  
■ 200 | 203cm.

■ 90 | 93 cm.  
■ 140 | 143 cm.  
■ 150 | 153 cm.  
■ 160 | 163 cm.  
■ 180 | 183 cm.

### Colchão . Mattress . Colchón . Matelas

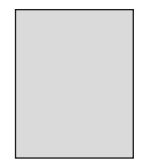

■ 190 | 190cm.  
■ 195 | 195 cm.  
■ 200 | 200cm.

■ 90 | 90 cm.  
■ 140 | 140 cm.  
■ 150 | 150 cm.  
■ 160 | 160 cm.  
■ 180 | 180 cm.

30 cm | 10 + 20 cm.



■ 190 | 193cm.  
■ 195 | 198 cm.  
■ 200 | 203cm.



# Headboard M-101

---

Quando o caminho certo, é a maneira mais simples.

*When the right path, is the simplest way.*

Cuando el camino correcto, es la forma más sencilla.

*Lorsque le bon chemin, est le moyen le plus simple.*

---





Fig.1



Fig.2

**Fig.1** - Com Sommier MP-05. *With MP-05 Sommier. Con Sommier MP-05. Avec sommier MP-05.*

**Fig.2** - Com Sommier MP-10. *With MP-10 Sommier. Con Sommier MP-10. Avec sommier MP-10.*

## M-101 SPECIFICATIONS

## Cabeceira . Headboard . Cabecero . Tête de Lit.

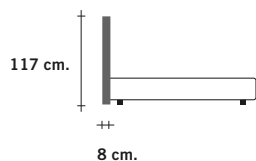

■ 90 | 93 cm.  
 ■ 140 | 143 cm.  
 ■ 150 | 153 cm.  
 ■ 160 | 163 cm.  
 ■ 180 | 183 cm.

## Colchão . Mattress . Colchón . Matelas

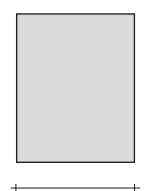

■ 190 | 190cm.  
 ■ 195 | 195 cm.  
 ■ 200 | 200cm.

■ 90 | 90 cm.  
 ■ 140 | 140 cm.  
 ■ 150 | 150 cm.  
 ■ 160 | 160 cm.  
 ■ 180 | 180 cm.







# Headboard M-102

---

Por vezes necessitamos apenas de um detalhe.

*Sometimes we just need a little detail.*

A veces solo necesitamos un pequeño detalle.

*Parfois, nous avons juste besoin d'un petit détail.*

---







Fig.1



Fig.2

**Fig.1** - Com Sommier MP-05. *With MP-05 Sommier. Con Sommier MP-05. Avec sommier MP-05.*

**Fig.2** - Com Sommier MP-10. *With MP-10 Sommier. Con Sommier MP-10. Avec sommier MP-10.*

M-102 SPECIFICATIONS

Cabeceira . Headboard . Cabecero . Tête de Lit.

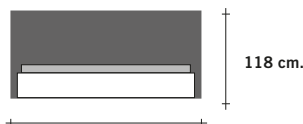
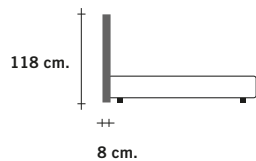

- 90 | 93 cm.
- 140 | 143 cm.
- 150 | 153 cm.
- 160 | 163 cm.
- 180 | 183 cm.

Colchão . Mattress . Colchón . Matelas

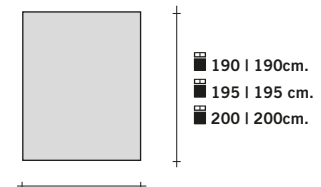

- 90 | 90 cm.
- 140 | 140 cm.
- 150 | 150 cm.
- 160 | 160 cm.
- 180 | 180 cm.



# Headboard M-103

---

O quebrar do horizonte, sob a forma de uma linha curva.

*The breaking of the horizon, in the form of a curved line.*

La ruptura del horizonte, en forma de línea curva.

*La rupture de l'horizon, sous la forme d'une ligne courbe.*

---





Fig.1



Fig.2

**Fig.1** - Com Sommier MP-05. *With MP-05 Sommier. Con Sommier MP-05. Avec sommier MP-05.*

**Fig.2** - Com Sommier MP-10. *With MP-10 Sommier. Con Sommier MP-10. Avec sommier MP-10.*

## M-103 SPECIFICATIONS

## Cabeceira . Headboard . Cabecero . Tête de Lit.

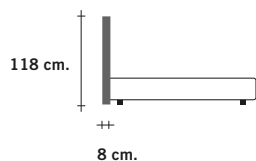

- 90 | 93 cm.
- 140 | 143 cm.
- 150 | 153 cm.
- 160 | 163 cm.
- 180 | 183 cm.

## Colchão . Mattress . Colchón . Matelas

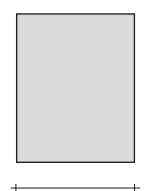

- 190 | 190cm.
- 195 | 195 cm.
- 200 | 200cm.

- 90 | 90 cm.
- 140 | 140 cm.
- 150 | 150 cm.
- 160 | 160 cm.
- 180 | 180 cm.





**Demand**

Personalize your Refreshment Center  
Customize your Refreshment Center

When you make a reservation, you can personalize your Refreshment Center. Select from a variety of items to create a Refreshment Center that is just what you need. You can also select from a variety of items to create a Refreshment Center that is just what you need.

ITEM	PRICE
Large Soft Drink	\$2.50
Large Hard Soft Drink	\$3.50
Large Hard Soft Drink with Lemon	\$4.50
Large Hard Soft Drink with Lime	\$4.50
Large Hard Soft Drink with Orange	\$4.50
Large Hard Soft Drink with Peach	\$4.50
Large Hard Soft Drink with Apple	\$4.50
Large Hard Soft Drink with Raspberry	\$4.50
Large Hard Soft Drink with Strawberry	\$4.50
Large Hard Soft Drink with Blueberry	\$4.50
Large Hard Soft Drink with Blackberry	\$4.50
Large Hard Soft Drink with Elderberry	\$4.50
Large Hard Soft Drink with Pomegranate	\$4.50
Large Hard Soft Drink with Dragonfruit	\$4.50
Large Hard Soft Drink with Passion Fruit	\$4.50
Large Hard Soft Drink with Guava	\$4.50
Large Hard Soft Drink with Mango	\$4.50
Large Hard Soft Drink with Pineapple	\$4.50
Large Hard Soft Drink with Kiwi	\$4.50
Large Hard Soft Drink with Peach	\$4.50
Large Hard Soft Drink with Apple	\$4.50
Large Hard Soft Drink with Raspberry	\$4.50
Large Hard Soft Drink with Strawberry	\$4.50
Large Hard Soft Drink with Blueberry	\$4.50
Large Hard Soft Drink with Blackberry	\$4.50
Large Hard Soft Drink with Elderberry	\$4.50
Large Hard Soft Drink with Pomegranate	\$4.50
Large Hard Soft Drink with Dragonfruit	\$4.50
Large Hard Soft Drink with Passion Fruit	\$4.50
Large Hard Soft Drink with Guava	\$4.50
Large Hard Soft Drink with Mango	\$4.50
Large Hard Soft Drink with Pineapple	\$4.50
Large Hard Soft Drink with Kiwi	\$4.50

**BOXED WATER IS BETTER.**

REUSE YOUR TOWEL.  
TURN OFF THE LIGHTS.  
DRINK BOXED WATER.

In dedication to protecting the environment, we've partnered with Boxed Water to help end plastic bottles.

**BOXED WATER IS BETTER.**

PURIFIED WATER  
11.8 FL. OZ. 0.74 PT. 330 ML.



# Headboard M-104

---

Simples, elegante, talvez até diferente.

*Simple, elegant, maybe even different.*

Simple, elegante, tal vez incluso diferente.

*Simple, élégant, peut-être même différent.*

---







Fig.1



Fig.2

**Fig.1** - Com Sommier MP-05. *With MP-05 Sommier. Con Sommier MP-05. Avec sommier MP-05.*

**Fig.2** - Com Sommier MP-10. *With MP-10 Sommier. Con Sommier MP-10. Avec sommier MP-10.*

M-104-SPECIFICATIONS

Cabeceira . Headboard . Cabecero . Tête de Lit.

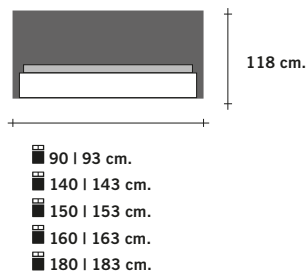
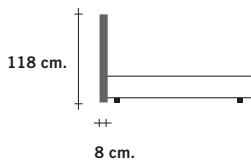

Colchão . Mattress . Colchón . Matelas

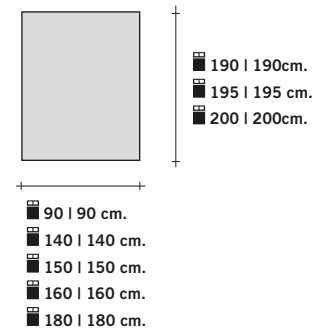



# Headboard M-105

---

O evocar da verticalidade das nossas ideias.  
*Evoking the verticality of our ideas.*  
Evocando la verticalidad de nuestras ideas.  
*Evoquer la verticalité de nos idées.*

---





Fig.1



Fig.2

**Fig.1** - Com Sommier MP-05. *With MP-05 Sommier. Con Sommier MP-05. Avec sommier MP-05.*

**Fig.2** - Com Sommier MP-10. *With MP-10 Sommier. Con Sommier MP-10. Avec sommier MP-10.*

## M-105 SPECIFICATIONS

## Cabeceira . Headboard . Cabecero . Tête de Lit.

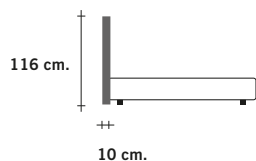

- 90 | 93 cm.
- 140 | 143 cm.
- 150 | 153 cm.
- 160 | 163 cm.
- 180 | 183 cm.

## Colchão . Mattress . Colchón . Matelas

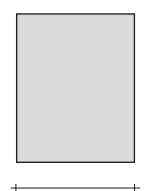

- 190 | 190cm.
- 195 | 195 cm.
- 200 | 200cm.

- 90 | 90 cm.
- 140 | 140 cm.
- 150 | 150 cm.
- 160 | 160 cm.
- 180 | 180 cm.







# Headboard M-106

---

Um olhar sobre o passado, que se alia à modernidade.

*A look at the past, which is allied to modernity.*

Una mirada al pasado, que se alía con la modernidad.

*Un regard sur le passé, qui s'allie à la modernité.*

---







Fig.1



Fig.2

**Fig.1** - Com Sommier MP-05. *With MP-05 Sommier. Con Sommier MP-05. Avec sommier MP-05.*

**Fig.2** - Com Sommier MP-10. *With MP-10 Sommier. Con Sommier MP-10. Avec sommier MP-10.*

M-106 SPECIFICATIONS

Cabeceira . Headboard . Cabecero . Tête de Lit.

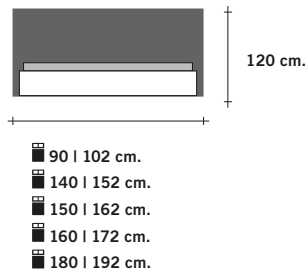
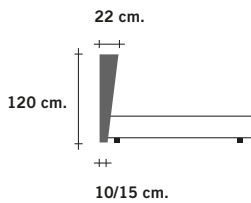

Colchão . Mattress . Colchón . Matelas

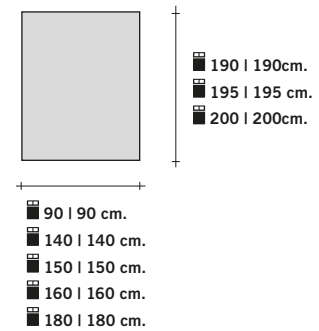



# Headboard M-107

---

O sentimento acolhedor que encontramos na simplicidade.

*The cozy feeling we find in simplicity.*

La sensación acogedora la encontramos en la sencillez.

*La sensation de confort que l'on retrouve dans la simplicité.*

---





Fig.1



Fig.2

**Fig.1** - Com Sommier MP-05. *With MP-05 Sommier. Con Sommier MP-05. Avec sommier MP-05.*

**Fig.2** - Com Sommier MP-10. *With MP-10 Sommier. Con Sommier MP-10. Avec sommier MP-10.*

## M-107 SPECIFICATIONS

## Cabeceira . Headboard . Cabecero . Tête de Lit.

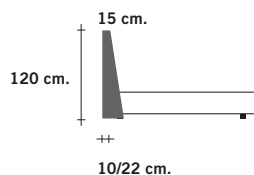

■ 90 | 102 cm.  
■ 140 | 152 cm.  
■ 150 | 162 cm.  
■ 160 | 172 cm.  
■ 180 | 192 cm.

## Colchão . Mattress . Colchón . Matelas

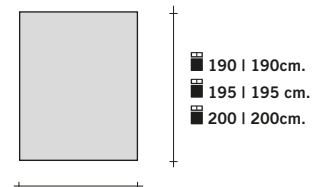

■ 90 | 90 cm.  
■ 140 | 140 cm.  
■ 150 | 150 cm.  
■ 160 | 160 cm.  
■ 180 | 180 cm.





M-51



M-52



M-53



M-54



M-55







# M-51

---

A inspiração, traz-nos uma mistura de linhas.

*Inspiration brings us a mixture of lines.*

La inspiración nos trae una mezcla de líneas.

*L'inspiration nous apporte un mélange de lignes.*

---





---

Tudo se resume ao conforto. E as espumas de alta densidade ajudam a atingir esse objetivo.

*It all comes down to comfort. And high-density foams help achieve that goal.*

Todo se reduce a la comodidad. Y las espumas de alta densidad ayudan a lograr ese objetivo.

*Tout est question de confort. Et les mousses à haute densité aident à atteindre cet objectif.*

---

---

#### M-51 SPECIFICATIONS

Cadeiraão . Armchair . Sillón . Fauteuil

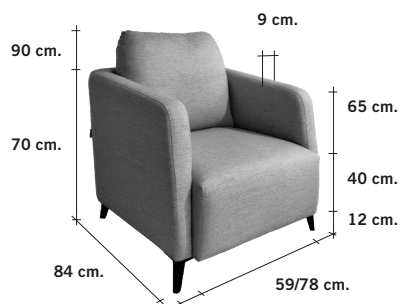





# M-52

---

Conforto, com uma pitada de pormenor.

*Comfort, with a hint of detail.*

Comodidad, con un toque de detalle.

*Confort, avec un soupçon de détail.*

---





Espumas de alta densidade proporcionam um excelente grau de conforto.

*High density foams provide an excellent degree of comfort.*

Las espumas de alta densidad proporcionan un excelente grado de comodidad.

*Les mousses à haute densité offrent un excellent degré de confort.*

#### M-52 SPECIFICATIONS

1 🪑 Sofá . Sofa . Sofá . Canapé

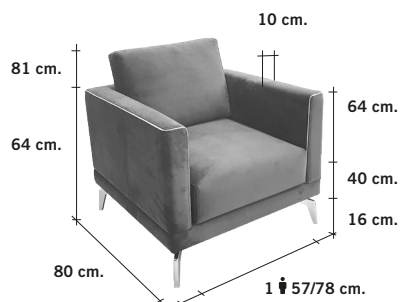

2 🪑 Sofá . Sofa . Sofá . Canapé

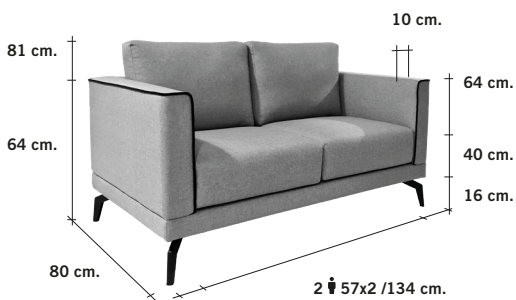





3 🪑 Sofá . Sofa . Sofá . Canapé





# M-53

---

Linhas curvas, arredondadas, com uma certa nostalgia.

*Curved lines, rounded, with a certain nostalgia.*

Líneas curvas, redondeadas, con cierta nostalgia.

*Des lignes courbes, arrondies, avec une certaine nostalgie.*

---





Tudo se resume ao conforto. E as espumas de alta densidade ajudam a atingir esse objetivo.

*It all comes down to comfort. And high-density foams help achieve that goal.*

Todo se reduce a la comodidad. Y las espumas de alta densidad ayudan a lograr ese objetivo.

*Tout est question de confort. Et les mousses à haute densité aident à atteindre cet objectif.*

#### M-53 SPECIFICATIONS

1 🪑 Sofá . Sofa . Sofá . Canapé

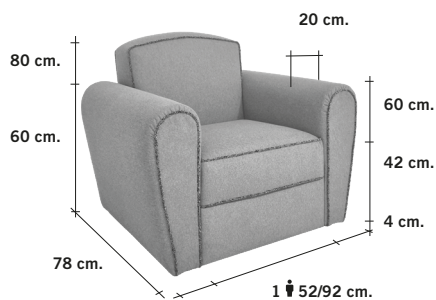

2 🪑 Sofá . Sofa . Sofá . Canapé

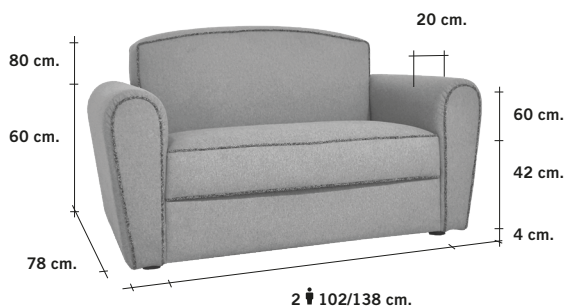



3 🪑 Sofá . Sofa . Sofá . Canapé





# M-54

---

Acolhedor, singelo, ideal para aquele momento de pausa.

*Cozy, simple, ideal for that moment of pause.*

Acogedor, sencillo, ideal para ese momento de pausa.

*Comfortable, simple, idéal pour ce moment de pause.*

---





---

Espumas de alta densidade proporcionam um excelente grau de conforto.

*High density foams provide an excellent degree of comfort.*

Las espumas de alta densidad proporcionan un excelente grado de comodidad.

*Les mousses à haute densité offrent un excellent degré de confort.*

---

---

#### M-54 SPECIFICATIONS

Cadeira . Armchair . Sillón . Fauteuil

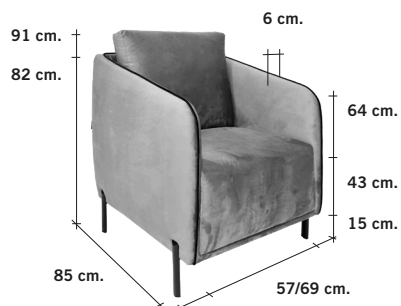







# M-55

---

Um olhar diferente, uma inspiração de outras formas.

*A different look, an inspiration in other ways.*

Una mirada diferente, una inspiración en otros sentidos.

*Un regard différent, une inspiration d'autres manières.*

---





---

Tudo se resume ao conforto. E as espumas de alta densidade ajudam a atingir esse objetivo.

*It all comes down to comfort. And high-density foams help achieve that goal.*

Todo se reduce a la comodidad. Y las espumas de alta densidad ayudan a lograr ese objetivo.

*Tout est question de confort. Et les mousses à haute densité aident à atteindre cet objectif.*

---

---

#### M-55 SPECIFICATIONS

Cadeiraão . Armchair . Sillón . Fauteuil

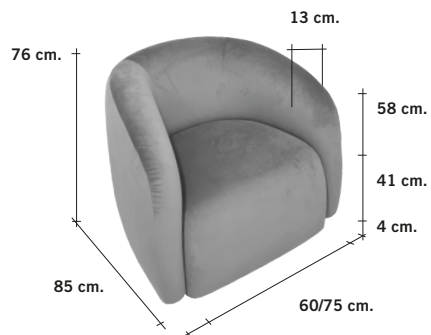





M-201



M-202



M-203



M-204





---

M-201 SPECIFICATIONS

Pufe . Pouff . Puf . Pouf

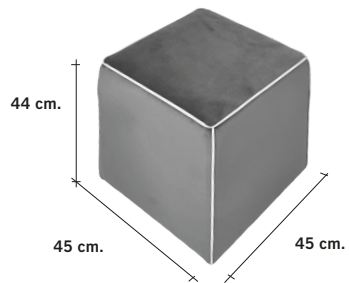



# M-201

---

A união das formas retas, adocicadas com um detalhe informal.  
*The union of straight shapes, sweetened with an informal detail.*  
La unión de formas rectas, endulzada con un detalle informal.  
*L'union de formes droites, adoucie par un détail informel.*

---





---

M-201 SPECIFICATIONS

Pufe . Pouff . Puf . Pouf

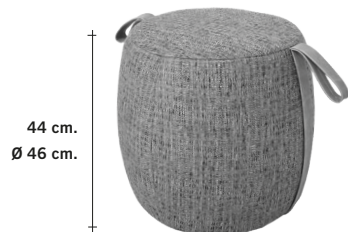

# M-202

---

Estética que se funde com o sentido prático.  
*Aesthetics that merges with the practical sense.*  
Estética que se funde con el sentido práctico.  
*Esthétique qui se confond avec le sens pratique.*

---





---

M-203 SPECIFICATIONS

Pufe . Pouff . Puf . Pouf

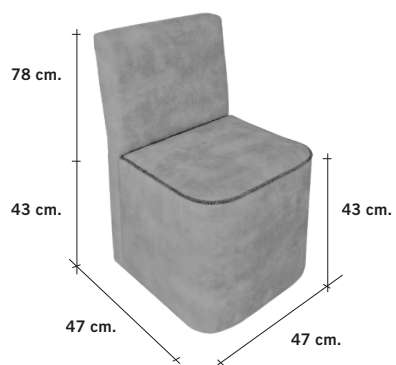

# M-203

---

Da mistura de linhas e pormenores, surgem por vezes as nossas ideias mais práticas.

*From the mixture of lines and details, our most practical ideas sometimes emerge.*

De la mezcla de líneas y detalles, a veces surgen nuestras ideas más prácticas.

*Du mélange des lignes et des détails, émergent parfois nos idées les plus pratiques.*

---





---

M-204 SPECIFICATIONS

Pufe . Pouff . Puf . Pouf

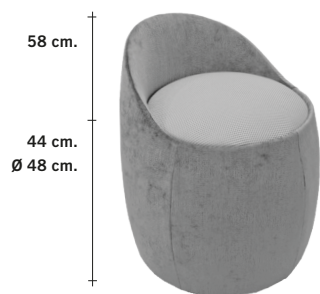

# M-204

---

Linhas curvas, elegantes, evocando a montanha nos nossos sentimentos.

*Curved, elegant lines, evoking the mountain in our feelings.*

Líneas curvas y elegantes, evocando la montaña en nuestros sentimientos.

*Lignes courbes et élégantes, évoquant la montagne dans nos sentiments.*

---





M-51



M-52



# Bar Sofas

---

Para um momento de pausa ou de reflexão, versatilidade modular e elegância, a nossa visão para um espaço multifacetado.

*For a moment of pause or reflection, modular versatility and elegance, our vision for a multifaceted space.*

Para un momento de pausa o reflexión, versatilidad modular y elegancia, nuestra visión de un espacio multifacético.

*Pour un moment de pause ou de réflexion, versatilité modulable et élégance, notre vision d'un espace aux multiples facettes.*

---



# M-220

---

Um olhar simples e elegante, sob um momento descontraído.

*A simple and elegant look, under a relaxed moment.*

Un look sencillo y elegante, bajo un momento relajado.

*Un look simple et élégant, sous un moment décontracté.*

---





Conforto com as espumas de alta densidade. Versatilidade com o sistema modular.

*Comfort with high density foams. Versatility with the modular system.*

Confort with high density foams. Versatility with the modular system.

*Confort avec mousses haute densité. Polyvalence avec le système modulaire.*

#### M-220 SPECIFICATIONS

Sofá s/ Braços . n/ Arms Sofa . Sofá s/ Brazos . Canapé s/ Bras

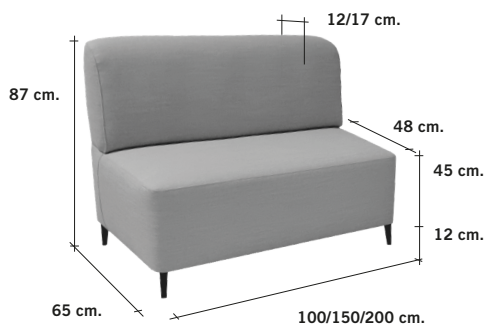

Canto . Corner . Esquina . Angle

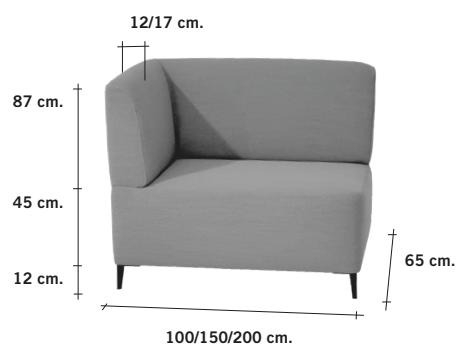



M-220



# M-221

---

Elegância sob a forma de linhas verticais.

*Elegance in the form of vertical lines..*

Elegancia en forma de líneas verticales.

*Élégance sous forme de lignes verticales.*

---





Conforto com as espumas de alta densidade. Versatilidade com o sistema modular.

*Comfort with high density foams.*

*Versatility with the modular system.*

Conforto com high density foams.

*Versatility with the modular system.*

*Confort avec mousses haute*

*densité. Polyvalence avec le système modulaire.*

#### M-221 SPECIFICATIONS

Sofá s/ Braços . n/ Arms Sofa . Sofá s/ Brazos . Canapé s/ Bras

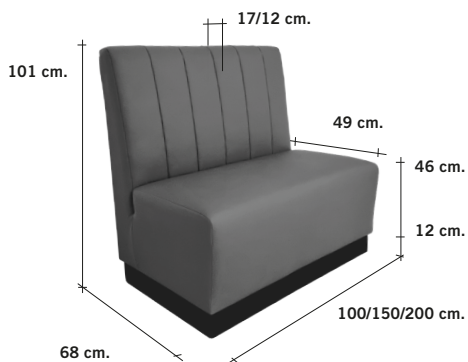

Canto . Corner . Esquina . Angle

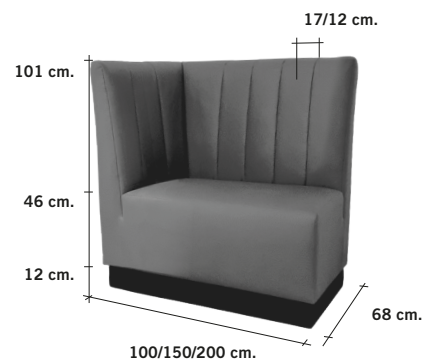











# CONTRACT

FURNITURE FOR PROFESSIONALS CATALOGUE

by **mhr**<sup>®</sup>  
UPHOLSTERY

